



ORDER FORM

Print pages 1-23 to exclude pictures.

October 2024

Q700M with SEDEO[®] PRO[™], SEDEO LITE[™] AADL - W581 and JAY Syncra Seating **EIPW25**

Customer	Ship To	
Account #	Name	
Date	Address	
PO#	City	
Buyer	Province	Postal Code
Mark For	Phone	

Client Measurements

a) Top of head to seat	in
b) Top of shoulder to seat	in
c) Underarm to seat	in
d) Elbow to seat	in
e) Top of leg to seat	in
f) Shoulder width	in
g) Chest width	in
i) Hip width	in
j) Actual sitting depth	in
m) Foot length	in
n) Knee to foot	in
o) Seat width	in

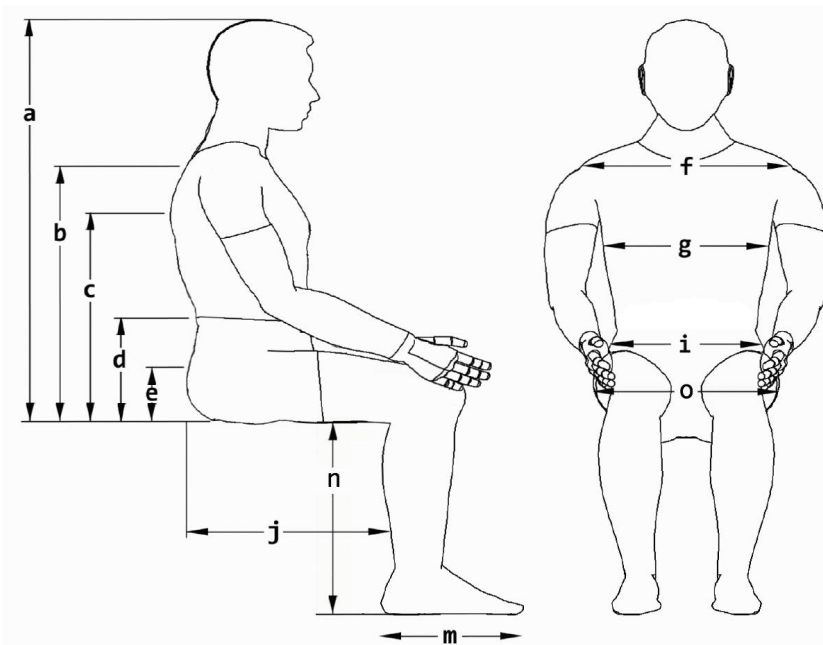

Notes

Chair Specifications

Weights Starting at: (with Batteries)	NPC: 294 lbs. SPC: 318 lbs.
Power Seating	50° of CG Tilt 12" seat elevator
Seat Type	SEDEO® PRO™/ SEDEO® LITE™/ JAY Syncra
Seat Size Range	Width 15" to 20" Depth 16" to 22"
Seat-to-Floor Height Range	16.5" to 19"

Mid-Wheel Drive Base Specifications

Drive Wheel Position	Mid-wheel drive
User Weight Capacity	250 lbs. / 300 lbs. / 350 lbs. HD / 450 lbs. HD
Base Size	Width 25", Length 36.5"
Minimum Turning Radius	19.8" (excludes footplates)
Drive Control	R-net PM 120A / R-net PM 90A
Driving Range	Up to 18 miles (w/ Group 24 Batteries)
Drive Motors	4-pole 6 mph, 5 mph HD, 8 mph
Drive Wheels	14" w/flat-free inserts (black) 14" w/pneumatic inserts (black)
Casters	6" front / 6" rear (black)
Charger	10A Dual Mode (Compact)
Battery Size	Group 24 / Group 34
Color	Matte Black with 6 color accents
Maximum Ground Clearance	3"

BASE			
OPTION		DESCRIPTION	RETAIL
Standard Duty Mid Wheel Drive Base <i>End Item Number EIPW25 (PRO™ Seat)</i>			\$
250PC197		Quickie Q700 M NPC No Power Option for SEDEO® PRO™ Seat Included in Base Pricing : Q700 M Base, R-net 90amp Electronics for No Power Seat Functions, SpiderTrac 2.0 Six-Wheel Independent Suspension, 14" Drive Wheels with Dual Density Inserts, 6" Flat Free Casters, ISO Occupied Tie-Down Brackets and 10amp Charger. Max Speed = 6mph, Weight Capacity = 300lbs., STFH = 16.5". (AADL Contract Price)	\$8,340.00
250PC198		Quickie Q700 M SPC Single Power Option for SEDEO® PRO™ Seat Included in Base Pricing : Q700 M Base, R-net 90amp Electronics for Single Power Seat Functions, SpiderTrac 2.0 Six-Wheel Independent Suspension, 14" Drive Wheels with Dual Density Inserts, 6" Flat Free Casters, ISO Occupied Tie-Down Brackets and 10amp Charger. Max Speed = 6mph, Weight Capacity = 300lbs., STFH = 16.5". (AADL Contract Price)	\$8,340.00
250PC198		Quickie Q700 M MPC Multi Power Option for SEDEO® PRO™ Seat Included in Base Pricing: Q700 M Base, R-net 90amp Electronics for Multiple Power Seat Functions, SpiderTrac 2.0 Six-Wheel Independent Suspension, 14" Drive Wheels with Dual Density Inserts, 6" Flat Free Casters, ISO Occupied Tie-Down Brackets and 10amp Charger. Max Speed = 6mph, Weight Capacity = 300lbs., STFH = 16.5". (AADL Contract Price)	8,340.00
Heavy Duty Mid Wheel Drive Base <i>End Item Number EIPW25 (PRO™ Seat)</i>			\$
250PC199		Quickie Q700 M NPC HD No Power Option for SEDEO® PRO™ Seat Included in Base Pricing : Q700 M Base, R-net 90amp Electronics for No Power Seat Functions, SpiderTrac 2.0 Six-Wheel Independent Suspension, 14" Drive Wheels with Dual Density Inserts, 6" Flat Free Casters, ISO Occupied Tie-Down Brackets and 10amp Charger. Max Speed = 5mph, Weight Capacity = 450lbs., STFH = 16.5". (AADL Contract Price)	\$9,822.00
250PC200		Quickie Q700 M SPC HD Single Power Option for SEDEO® PRO™ Seat Included in Base Pricing : Q700 M Base, R-net 90amp Electronics for Single Power Seat Functions, SpiderTrac 2.0 Six-Wheel Independent Suspension, 14" Drive Wheels with Dual Density Inserts, 6" Flat Free Casters, ISO Occupied Tie-Down Brackets and 10amp Charger. Max Speed = 5mph, Weight Capacity = 450lbs., STFH = 16.5". (AADL Contract Price)	\$9,822.00
250PC204		Quickie Q700 M MPC HD Multi Power Option for SEDEO® PRO™ Seat Included in Base Pricing : Q700 M Base, R-net 90amp Electronics for Multi Power Seat Functions, SpiderTrac 2.0 Six-Wheel Independent Suspension, 14" Drive Wheels with Dual Density Inserts, 6" Flat Free Casters, ISO Occupied Tie-Down Brackets and 10amp Charger. Max Speed = 5mph, Weight Capacity = 450lbs., STFH = 16.5". (Client Cost)	\$9,822.00
High Performance 8mph Mid Wheel Drive Base <i>End Item Number EIPW25 (PRO™ Seat)</i>			\$
250PC201		Quickie Q700 M NPD HD No Power Option for SEDEO® PRO™ Seat Included in Base Pricing : Q700 M Base, R-net 120amp Electronics for No Power Seat Functions, SpiderTrac 2.0 Six-Wheel Independent Suspension, 14" Drive Wheels with Dual Density Inserts, 6" Flat Free Casters, ISO Occupied Tie-Down Brackets and 10amp Charger. Max Speed = 8mph, Weight Capacity = 300lbs., STFH = 16.5". (Client Cost)	\$10,622.00
250PC202		Quickie Q700 M SPD HD Single Power Option for SEDEO® PRO™ Seat Included in Base Pricing : Q700 M Base, R-net 120amp Electronics for Single Power Seat Functions, SpiderTrac 2.0 Six-Wheel Independent Suspension, 14" Drive Wheels with Dual Density Inserts, 6" Flat Free Casters, ISO Occupied Tie-Down Brackets and 10amp Charger. Max Speed = 8mph, Weight Capacity = 300lbs., STFH = 16.5". (Client Cost)	\$10,622.00
250PC203		Quickie Q700 M MPD HD Multi Power Option for SEDEO® PRO™ Seat Included in Base Pricing : Q700 M Base, R-net 120amp Electronics for Multi Power Seat Functions, SpiderTrac 2.0 Six-Wheel Independent Suspension, 14" Drive Wheels with Dual Density Inserts, 6" Flat Free Casters, ISO Occupied Tie-Down Brackets and 10amp Charger. Max Speed = 8mph, Weight Capacity = 300lbs., STFH = 16.5". (Client Cost)	\$10,622.00

BASE			
OPTION		DESCRIPTION	RETAIL
Standard Duty Mid Wheel Drive Base <i>End Item Number EIPW25 (LITE™ Seat)</i>			\$
250PC267		Quickie Q700 M NPC No Power Option for SEDEO® LITE™ Seat Included in Base Pricing : Q700 M Base, R-net 90amp Electronics for No Power Seat Functions, SpiderTrac 2.0 Six-Wheel Independent Suspension, 14" Drive Wheels with Dual Density Inserts, 6" Flat Free Casters, ISO Occupied Tie-Down Brackets and 10amp Charger. Max Speed = 6mph, Weight Capacity = 300lbs., STFH = 16.5". (AADL Contract Price)	\$8,340.00
250PC268		Quickie Q700 M SPC Single Power Option for SEDEO® LITE™ Seat Included in Base Pricing : Q700 M Base, R-net 90amp Electronics for Single Power Seat Functions, SpiderTrac 2.0 Six-Wheel Independent Suspension, 14" Drive Wheels with Dual Density Inserts, 6" Flat Free Casters, ISO Occupied Tie-Down Brackets and 10amp Charger. Max Speed = 6mph, Weight Capacity = 300lbs., STFH = 16.5". (AADL Contract Price)	\$8,340.00
Heavy Duty Mid Wheel Drive Base <i>End Item Number EIPW25 (LITE™ Seat)</i>			\$
250PC269		Quickie Q700 M NPC HD No Power Option for SEDEO® LITE™ Seat Included in Base Pricing : Q700 M Base, R-net 90amp Electronics for No Power Seat Functions, SpiderTrac 2.0 Six-Wheel Independent Suspension, 14" Drive Wheels with Dual Density Inserts, 6" Flat Free Casters, ISO Occupied Tie-Down Brackets and 10amp Charger. Max Speed = 5mph, Weight Capacity = 350lbs., STFH = 16.5". (AADL Contract Price)	\$9,822.00
250PC270		Quickie Q700 M SPC HD Single Power Option for SEDEO® LITE™ Seat Included in Base Pricing : Q700 M Base, R-net 90amp Electronics for Single Power Seat Functions, SpiderTrac 2.0 Six-Wheel Independent Suspension, 14" Drive Wheels with Dual Density Inserts, 6" Flat Free Casters, ISO Occupied Tie-Down Brackets and 10amp Charger. Max Speed = 5mph, Weight Capacity = 350lbs., STFH = 16.5". (AADL Contract Price)	\$9,822.00
High Performance 8mph Mid Wheel Drive Base <i>End Item Number EIPW25 (LITE™ Seat)</i>			\$
250PC271		Quickie Q700 M NPD No Power Option for SEDEO® LITE™ Seat Included in Base Pricing : Q700 M Base, R-net 90amp Electronics for No Power Seat Functions, SpiderTrac 2.0 Six-Wheel Independent Suspension, 14" Drive Wheels with Dual Density Inserts, 6" Flat Free Casters, ISO Occupied Tie-Down Brackets and 10amp Charger. Max Speed = 8mph, Weight Capacity = 300lbs., STFH = 16.5". (Client Cost)	\$10,622.00
250PC272		Quickie Q700 M SPD Single Power Option for SEDEO® LITE™ Seat Included in Base Pricing : Q700 M Base, R-net 90amp Electronics for Single Power Seat Functions, SpiderTrac 2.0 Six-Wheel Independent Suspension, 14" Drive Wheels with Dual Density Inserts, 6" Flat Free Casters, ISO Occupied Tie-Down Brackets and 10amp Charger. Max Speed = 8mph, Weight Capacity = 300lbs., STFH = 16.5". (Client Cost)	\$10,622.00

BASE			
OPTION		DESCRIPTION	RETAIL
User Weight			\$
250WG22		Up to 250 lbs.	NC
250WG03		251 to 300 lbs.	NC
250WG15		301 to 350 lbs.	NC
250WG25		351 to 450 lbs.	NC
Motor Package			\$
250PF98		4-pole 8 kph / 5 mph <i>(Standard for Group 3 HD)</i>	NC
250PF99		4-pole 10 kph / 6 mph <i>(Standard for Group 3)</i>	NC
250PF101		4-pole 12.5 kph / 8 mph <i>(Upgrade for Group 3)</i> (Client Cost)	\$1,249.00
Tracking			\$
250MI01		SureTrac® Module & Motor Encoders <i>(Improves drive tracking)</i>	\$1,671.00
Drive Wheels  P. 24			\$
250DW58		Drive Wheel, 14", Dual Density, Knobby, Black	NC
Wheel Locks			\$
250WL42		Wheel Locks	\$138.00
Shroud Color			\$
250C119		Matte Black	NC
250C125		Pearl White	NC
250C165		Candy Apple Red	NC
250C166		Candy Blue	NC
250C167		Candy Purple	NC
250C176		Green Apple	NC
250C178		Pearl Pink	NC
250C182		Silver	NC
Color Accents			\$
250EZ20		Apple Green	NC
250EZ22		Black	NC
250EZ21		Blue	NC
250EZ23		Orange	NC
250EZ24		Red	NC
250EZ19		White	NC
250EZ25		Silver	NC

BASE

OPTION	DESCRIPTION	RETAIL
--------	-------------	--------

ISO Transit Tie Downs \$

250TO50	ISO Transit Package	NC
---------	---------------------	----

LED Lights  P. 23 \$

250LI04	LED Lights and Indicators (Client Cost)	\$1,207.00
250LI02	Omit LED Lights	NC

Seat Heights \$

Note: Available seat-to-floor heights are dependent on 2 options: **1- Battery Size** and **2- Powered Seating**.
Use the matrix below to determine available ranges for your desired options. Measured from front of seat pan to floor with 0° frame angle.

	Seat Height	Power Seating	No Power Seating	
250HT103	16.5"	Group 34	Group 34	NC
250HT55	17"	Group 34	GP24 or GP34	NC
250HT104	17.5"	Group 34	GP24 or GP34	NC
250HT56	18"	GP24 or GP34	GP24 or GP34	NC
250HT105	18.5"	GP24 or GP34	GP24 or GP34	NC
250HT57	19"	GP24 or GP34	GP24 or GP34	NC

Batteries and Chargers (AADL Contract Pricing)  P. 24 \$**Group 24 Battery Options (Recommended for max daily range)**

250AG25	GP24 Flat Top Pair w/Strap Gel	\$941.00
250AG26	GP24 Flat Top Pair w/Strap AGM	\$901.00

Group 34 Battery Options (Required for lower seat-to-floor heights)

250AG27	GP34 Flat Top Pair w/Straps Gel	\$941.00
250AG29	GP34 Flat Top Pair w/Straps AGM	\$850.00

Omit Batteries

250AG24	Battery Harnesses Only (Omit Batteries)	NC
---------	---	----

Chargers

250BJ28	10A Dual Mode (Compact) Power First	NC
---------	-------------------------------------	----

POWERED SEATING

OPTION	DESCRIPTION	RETAIL
--------	-------------	--------

Power Seating Options  P. 24

\$

Seat Elevator (Client Cost)

250PI08	C-Me® Seat Elevator, Powered, 300 mm / 12" (Not available with HD model) For users less than 250 lbs. C-Me speed can reach 3 mph. For users 251 to 300 lbs. C-Me speed can reach 2.4 mph.	\$3,426.00
---------	--	------------

Seat Tilt (AADL W993 for Power Tilt)

250PA35	Posterior 50° Tilt	\$8,535.00
---------	--------------------	------------

Seat Recline (AADL W993TR for Power Recline)

250PA37	150° Powered Recline w/ 4" Shear Reduction	\$7,883.00
---------	--	------------

Seat Tilt/Recline (AADL W993TR for Tilt and Recline)

250PA41	Posterior 50° Tilt and 150° Recline Powered, w/ 4" Shear Reduction	\$13,079.00
---------	--	-------------

Pre Set Seat Frame Angle (No Power Seating Options, Increases Seat to Floor Height)

\$

250FA10	0° (Adds 0" to STFH)	NC
250FA3	3° (Adds 1" to STFH)	NC

Backrest Frame Type

\$

250BF10	Tool Angle Adjustable Back, 90°-120°	NC
250BF11	User Adjustable Manual Semi-Recline Back, 90°-130°, Right (Adjustment Lever Mounted on Opposite Side of Joystick)	\$812.00
250BF12	User Adjustable Manual Semi-Recline Back, 90°-130°, Left (Adjustment Lever Mounted on Opposite Side of Joystick)	\$812.00

Backrest Frame Option

\$

250BF23	Flip Down, Quick Release	\$176.00
---------	--------------------------	----------

Back Cushion Type

\$

250BT134	SEDEO® Back Cushion (Choose Seating in Section B)	NC
250BT148	SEDEO® LITE™ Sling Back with Tension Adjustable Straps (Choose Seating in Section A)	NC
250BT134	JAY® Syncra™ (Choose Seating in Section C)	NC
250BT135	JAY® J3® (Choose Seating in Section D)	NC
250BT137	SEDEO® PRO™ Aftermarket Back Adapter (Height Adjustable Round Tubes for Traditional Mounting)	\$624.00
250BT133	OMIT (For personalized mounting. No headrest mount)	NC

POWERED SEATING

OPTION	DESCRIPTION	RETAIL
A - SEDEO® LITE™ Backrest Frame (Angle Adjustable 86° - 106°)		\$

Back Frame Width

250BF21	Width Adjustable, 385 - 485 mm / 15" - 19"	NC
250BF22	Width Adjustable, 460 - 510 mm / 18" - 20"	NC

Back Cane Height

250B263	Standard, 18" - 20"	NC
250B264	Tall, 21" - 23"	NC

Backrest Frame Options

250BF23	Flip Down, Quick Release	\$176.00
250BF24	Removeable	NC
250PH30	Height Adjustable, Short w/ Trailing Push Handles (<i>Push Handle Height 20" - 22", N/A w/ Sling Back</i>)	NC
250PH31	Height Adjustable, Tall w/ Trailing Push Handles (<i>Push Handle Height 23 - 26", N/A w/ Sling Back</i>)	NC

A - SEDEO® LITE™ Sling Back Dimensions**Installed Back Height - (From Pan to Top of Back)**

250JR71	18"	NC
250JR72	19"	NC
250JR73	20"	NC
250JR74	21"	NC
250JR75	22"	NC
250JR76	23"	NC

B - SEDEO® Backrest Dimensions (Seating Benefits)**Back Width**

250BN28	400mm / 16"	NC
250BN29	460mm / 18"	NC
250BN30	500mm / 20"	NC
250BN31	560mm / 22"	NC

Back Shell Height

		Tool Angle Adj.	130° Recline	150° Recline	Installed Back Height	
250B255	460mm / 18"	22" - 23"	22"-24"	23"-25"		NC
250B256	560mm / 22"	24" - 27"	25" - 27"	26"-29"		NC
250B257	660mm / 26"	28" - 30"	28" - 30"	30"		NC

Installed Back Height - (From Pan to Top of Back)

250JR32	22"	NC
250JR33	23"	NC
250JR34	24"	NC
250JR35	25"	NC
250JR36	26"	NC
250JR37	27"	NC
250JR38	28"	NC
250JR39	29"	NC
250JR40	30"	NC

POWERED SEATING

OPTION	DESCRIPTION	RETAIL
C- JAY® Syncra™ Back (Seating Benefits)		NEW \$
250JP14	JAY® Syncra™ Back 16-20" Wide with 3" Contour Depth	\$1,319.00
250JP15	JAY® Syncra™ Back 22" Wide with 3" Contour Depth	\$1,319.00
C - JAY® Syncra™ Back Width		NEW \$
<i>Back can be ordered a different width than seat pan. Armrest will be adjusted to back width ordered.</i>		
250JQ07	16" Wide (Adjustment range 16 to 17" Wide)*	NC
250JQ08	18" Wide (Adjustment range 18 to 19" Wide)*	NC
250JQ09	20" Wide (Adjustment range 20 to 21" Wide)*	NC
250JQ10	22" Wide (Adjustment range 22 to 23" Wide)*	NC
<i>*Additional +1" of shell width adjustment is achievable. Requires purchase of 1" larger foam and upholstery separately.</i>		
C - JAY® Syncra™ Back Shell Options and Height Ranges		NEW \$
<i>JAY® Syncra™ Back shells are mounted with a minimum 5.5" gap between the bottom of the shell to the seat pan to accommodate the mechanical shear. Back height can be adjusted in the field with-in the ranges shown based on the back frame type.</i>		
JAY® Syncra™ Shell Height		
250JR42	16" Tall Shell (22" to 24" Back Height)	NC
250JR43	18" Tall Shell (24" to 26" Back Height)	NC
250JR44	20" Tall Shell (26" to 28" Back Height)	NC
250JR45	22" Tall Shell (28" to 30" Back Height)	NC
JAY® Syncra™ Back Installed Back Height (From Pan to Top of Back)		
250JR50	22" (16" Shell Height)	NC
250JR51	23" (16" Shell Height)	NC
250JR52	24" (16" Shell Height)	NC
250JR53	24" (18" Shell Height)	NC
250JR54	25" (18" Shell Height)	NC
250JR55	26" (18" Shell Height)	NC
250JR56	26" (20" Shell Height)	NC
250JR57	27" (20" Shell Height)	NC
250JR58	28" (20" Shell Height)	NC
250JR67	28" (22" Shell Height)	NC
250JR68	29" (22" Shell Height)	NC
250JR69	30" (22" Shell Height)	NC
C - JAY® Syncra™ Back Upholstery		
250BU96	Syncra™ Premium Leatherette	NC
250BU97	Syncra™ Stretch	NC

POWERED SEATING

OPTION	DESCRIPTION	RETAIL
D - JAY® J3® Back - Contour (Seating Benefits)  P. 24		
250JP01	J3® PA Back for 16"-20" Wide	\$899.00
250JP02	J3® PA Back for 22" Wide	\$1,912.00
250JP11	J3® PL Back for 16"-20" Wide	\$971.00
250JP13	J3® PD Back for 16"-20" Wide (18" and 21" shell height only)	\$1,052.00

D - JAY® J3® Back Width

Back can be ordered a different width than seat pan. Armrest will be adjusted to back width ordered.

250JQ02	16"	NC
250JQ03	18"	NC
250JQ04	20"	NC
250JQ05	22"	NC

D - JAY® J3® Back Shell Options and Height Ranges

JAY® J3® shells are mounted with a minimim 4" gap between the bottom of the shell to the seat pan to accommodate the mechanical shear. Back height can be adjusted in the field within the ranges shown, based on the back frame type and the amount of usable hardware adjustability.

JAY® J3® Shell Height

		Tool Angle Adj.	130° Recline	150° Recline	
250JR41	15" tall shell (Upper Thoracic Med) for 22" Wide	22" - 23"	21" - 22"	22" - 23"	Installed Back Height
250JR14	16.5" tall shell (Upper Thoracic Short)	21" - 23"	21" - 22"	21" - 23"	
250JR15	18" tall shell (Upper Thoracic Med)	22" - 24"	22" - 24"	23" - 25"	
250JR16	19.5" tall shell (Upper Thoracic Tall)	24" - 26"	24" - 26"	24" - 26"	
250JR18	18" tall shell (Shoulder Height) for 22" Wide	25" - 26"	24" - 25"	25" - 26"	
250JR17	21" tall shell (Shoulder Height)	24" - 26"	25" - 27"	26" - 28"	
250JR27	22.5" tall shell (Shoulder Height)	26" - 28"	27" - 29"	27" - 29"	
250JR28	24" tall shell (Shoulder Height)	27" - 29"	28" - 30"	29" - 30"	

JAY® J3® Installed Back Height (From Pan to Top of Back)

250JR29	21"	NC
250JR19	22"	NC
250JR20	23"	NC
250JR21	24"	NC
250JR22	25"	NC
250JR23	26"	NC
250JR24	27"	NC
250JR25	28"	NC
250JR30	29"	NC
250JR31	30"	NC

POWERED SEATING

OPTION	DESCRIPTION	RETAIL
D - JAY® Anterior Thoracic Support (Seating Benefits)  P. 25 \$		
<i>Classic-Structure Pull Down Harness (4 point strap, only available with JAY® backrest)</i>		
250K10	Medium (ATS8302)	\$317.00
250K11	Large (ATS8303)	\$317.00

D - JAY® Lateral Thoracic Swing-Away Supports (Requires Pad, Upholstery and Mount) \$**JAY® Lateral Thoracic Support Pads**

250JW35	Lateral Thoracic (LxH) 100 mm x 100 mm / 4" x 4" Pad - Right	\$71.00
250JW38	Lateral Thoracic (LxH) 100 mm x 100 mm / 4" x 4" Pad - Left	\$71.00
250JW36	Lateral Thoracic (LxH) 100 mm x 127 mm / 4" x 5" Pad - Right	\$71.00
250JW39	Lateral Thoracic (LxH) 100 mm x 127 mm / 4" x 5" Pad - Left	\$71.00
250JW37	Lateral Thoracic (LxH) 100 mm x 152 mm / 4" x 6" Pad - Right	\$71.00
250JW40	Lateral Thoracic (LxH) 100 mm x 152 mm / 4" x 6" Pad - Left	\$71.00

JAY® Lateral Thoracic Support Pad Upholstery

250NU01	Syncra™ Premium Leatherette	NC
250NU02	Syncra™ Stretch	NC

JAY® Lateral Thoracic Swing-Away Mount

250JW41	Lateral Thoracic Swing-Away Bracket - Right	\$317.00
250JW42	Lateral Thoracic Swing-Away Bracket - Left	\$317.00

Headrests (Requires Pad, Upholstery, & Mount) (Seating Benefits)  P. 25 \$**Headrest Pad**

250HE36	SEDEO® Pad Small With Cover (LxH) 240 x 150 mm / 10" x 6" <i>Can only be used with Multi Position Headrest Mount with Quick Release and SEDEO® Upholstery</i>	\$224.00
250HE38	Whitmyer® Plush Headrest Pad 203 mm / 8"	\$371.00
250HE39	Whitmyer® Plush Headrest Pad 254 mm / 10"	\$371.00
250HE44	Whitmyer® Plush Headrest Pad 356 mm / 14"	\$371.00
250HE46	Whitmyer® Adjust-A-Plush Headrest Pad Medium (<i>Adjustable from 7 to 16" Wide x 4" Tall</i>)	\$438.00
250HE48	OMIT Headrest Pad	NC

POWERED SEATING			
OPTION		DESCRIPTION	RETAIL
Headrest Pad Upholstery			
250NU10		SEDEO® Upholstery	NC
250NU04		Syncra™ Premium Leatherette	NC
250NU05		Syncra™ Premium Leatherette	NC
250NU11		Whitmyer® Lycra	NC
Headrest Mount			
250MH32		SEDEO® Multi-Position Headrest Mount with Quick Release <i>(Only available with SEDEO® Pad)</i>	\$549.00
250MH33		Whitmyer® Linx Headrest Mount with Quick Release	\$243.00
250MH34		Whitmyer® Linx-2 Headrest Mount with Quick Release	\$294.00
250MH35		Whitmyer® AXYS Headrest Mount with Quick Release	\$243.00
250MH17		OMIT Headrest Mount	NC
Push Handles \$			
250PH27		Height Adjustable Push Handles	\$60.00
Seat Frame Rails \$			
250SN14		Seat Rail Short, For Seat Depth 16" - 20" <i>(Effective depth 14" to 18")</i>	NC
250SN15		Seat Rail Long, For Seat Depth 19" - 22" <i>(Effective depth 17" to 20") (Not available with 16" seat width)</i>	NC
Seat Cushion Type \$			
250ST78		SEDEO® (See Section D)	NC
250ST79		JAY Syncra™ (See Section F)	NC
250ST80		JAY® (See Section E)	NC
250ST75		Omit	NC
Seat Size \$			
Seat Pan Width			
250R78		15" <i>(Not Available with Sedeo PRO)</i>	NC
250R53		16"	NC
250R54		17"	NC
250R55		18"	NC
250R56		19"	NC
250R57		20"	NC
250R58		21" <i>(Not Available with JAY® Syncra Cushions or Sedeo Lite)</i>	NC
250R59		22" <i>(Not Available with Sedeo Lite)</i>	NC
Seat Pan Depth (Front of Seat Pan to Back Structure. Back Cushions Can Cause 2" Loss of Effective Depth)			
250RF51		16"	NC
250RF45		17"	NC
250RF46		18"	NC
250RF47		19"	NC
250RF48		20"	NC
250RF49		21"	NC
250RF50		22"	NC
SEDEO® Cushions (Seating Benefits) \$			
250CU82		SEDEO® Cushion <i>(Sizes 16", 18", & 20" Wide) (Not Available with 14" Depth)</i>	\$315.00
250CU83		SEDEO® Cushion <i>(Sizes 22" Wide)</i>	\$529.00

POWERED SEATING

OPTION	DESCRIPTION	RETAIL
E - JAY® Seat Cushions (Seating Benefits)		\$
250CU59	JAY® Ion® (Sizes 16" - 21" Wide)	\$647.00
250CU60	JAY® Ion® (Size 22" Wide)	\$688.00
250CU61	JAY® Union® (Sizes 16" - 21" Wide)	\$753.00
250CU62	JAY® Union® (Size 22" Wide)	\$794.00
250CU64	JAY® Fusion® (Sizes 16-21" Wide)	\$1,030.00
250CU65	JAY® Fusion® (Size 22" Wide)	\$1,170.00

E - JAY® Solid Seat (Seating Benefits) \$

250CU84	JAY® Solid Seat	\$343.00
---------	-----------------	----------

E- JAY® Bundling \$

Note: To order any JAY® cushion not listed above please see the JAY® price list.

250JC20	JAY® Bundled Cushion	See Price List
	Cushion name or part number	Width Depth

F - JAY® Syncra Cushions (Seating Benefits) \$

250CU89	JAY® Syncra™ Cushion featuring JAY Flow® Fluid with Cryo™ Technology (16" to 20" wide)	\$1,002.00
250CU90	JAY® Syncra™ Cushion featuring JAY Flow® Fluid with Cryo™ Technology (22" wide)	\$1,108.00

JAY® Syncra™ Cushion Cover Upholstery

250YR73	Syncra™ Premium Leatherette	NC
250YR74	Syncra™ Stretch	NC

POSITIONING SUPPORTS & ACCESSORIES

OPTION	DESCRIPTION	RETAIL
Knee and Thigh Swing-Away Support Pads (Seating Benefits)		\$
Lateral Knee Support Pads and Hardware (must pick pad and mount)		
250XY05	Lateral Knee Support Pad, Right (4" round)	\$243.00
250XY06	Lateral Knee Support Pad, Left (4" round)	\$243.00
250XX08	Lateral Swing-Away Bracket Knee - Right	\$320.00
250XX09	Lateral Swing-Away Bracket Knee - Left	\$320.00
Lateral Thigh Support Pads and Hardware (must pick pad and mount)		
250KF22	Lateral Thigh Support Pad, Right (5"x5")	\$144.00
250KF23	Lateral Thigh Support Pad, Left (5"x5")	\$144.00
250KF24	Lateral Thigh Support Pad Long- Right (5"x7")	\$320.00
250KF25	Lateral Thigh Support Pad Long- Left (5"x7")	\$320.00
250KF26	Lateral Thigh Removable Mount - Right	\$320.00
250KF27	Lateral Thigh Removable Mount - Left	\$320.00
JAY® Lateral Thigh Supports (Must pick pad, upholstery, and mount) (Seating Benefits)		\$
JAY® Lateral Thigh Support Pads		
250KF16	Lateral Thigh Support Standard, Right (8.25" x 3.25")	\$144.00
250KF17	Lateral Thigh Support Standard, Left (8.25" x 3.25")	\$144.00
250KF18	Lateral Thigh Support Large, Right (12" x 3.25")	\$144.00
250KF19	Lateral Thigh Support Large, Left (12" x 3.25")	\$144.00
JAY® Lateral Thigh Support Pad Upholstery		
250NU07	Syncra™ Premium Leatherette	NC
250NU08	Syncra™ Stretch	NC
JAY® Lateral Thigh Removable Mount		
250KF20	Lateral Thigh Removable Mount - Right	\$320.00
250KF21	Lateral Thigh Removable Mount - Left	\$320.00
Armrest Structure	 P. 26	\$
250EG35	Reclining, Flip Back (Height Adjustable 8" to 13")	NC
250EG36	Reclining, Flip Back with 2-point post locking arm (Height Adjustable 11" to 13" x .625")	\$346.00
250EG32	Single Post, Flip Back (N/A with thigh support) (Height Adjustable 10" to 15")	NC
250EG34	Single Post, SEDEO LITE, Removable (N/A with thigh support), (Height Adjustable 10" to 15")	NC
Arm Pads	 P. 26	\$
SEDEO® Armrest Pad		
250AB62	300 mm / 12", Integral Foam, Right	NC
250AE62	300 mm / 12", Integral Foam, Left	NC
250AB63	400 mm / 16", Integral Foam, Right	NC
250AE63	400 mm / 16", Integral Foam, Left	NC
250AB61	SEDEO LITE Pad, Right	NC
250AE61	SEDEO LITE Pad, Left	NC

POSITIONING SUPPORTS & ACCESSORIES (Seating Benefits)

OPTION	DESCRIPTION	RETAIL
Comfort Arm Pad (Foam)		
250AB46	2" Wide Right	\$111.00
250AE46	2" Wide Left	\$111.00
Comfort Arm Pad (Gel)		
250AB48	2" Wide Right	\$210.00
250AE48	2" Wide Left	\$210.00
Ottobock® Arm Troughs		
250AE06	Ottobock® Arm Trough, Med (12") Left	\$137.00
250AB06	Ottobock® Arm Trough, Med (12") Right	\$137.00
250AE07	Ottobock® Arm Trough, Large (14") Left	\$137.00
250AB07	Ottobock® Arm Trough, Large (14") Right	\$137.00
2500L01	Ottobock® Hand Pad, Med (7"), Left	\$137.00
2500R01	Ottobock® Hand Pad, Med (7"), Right	\$137.00
2500L02	Ottobock® Hand Pad, Large (9"), Left	\$137.00
2500R02	Ottobock® Hand Pad, Large (9"), Right	\$137.00
250AE78	Ottobock® One Piece Arm Trough, (18") Left	\$137.00
250AB78	Ottobock® One Piece Arm Trough, (18") Right	\$137.00

Side Guards (Pair) (Client Cost)

250SG44	Side Guards Integral Foam (11"L x 5.5"H) (N/A with Reclining Armrests)	\$351.00
---------	--	----------

Fixed Centermount Legrest

250H183	SEDEO® Fixed Centermount Legrest (3" to 17.5" Leg Length)	\$346.00
250H184	Fixed Centermount Legrest, Short (Includes Calf Pads & Single Footplate) (11.5" to 14.5" Leg Length)	NC
250H185	Fixed Centermount Legrest, Long (Includes Calf Pads & Single Footplate) (13.5" to 18.5" Leg Length)	NC
250H136	Angle Adjustable Centermount Legrest, Long (Only Available with Sedeo Lite) (11.5" to 18.5" Leg Length)	\$596.00

Power Centermount Legrest (Client Cost)

P. 26

250H175	Power Centermount Legrest, 90° - 0° Angle, 7.5" Extension (Mechanical Articulation) (5" to 17.5" Leg Length)	\$2,450.00
250H109	Power Centermount Legrest, 90° - 0° Angle, 7.5" Extension (Powered Articulation) (3" to 17.5" Leg Length)	\$3,384.00

Power Centermount Legrest Accessories (Client Cost)**Footplates**

250F127	Dual, Height, Width and Angle Adjustable, Standard (14"W x 10"D)	\$280.00
250F128	Dual, Height, Width and Angle Adjustable, Large (16"W x 12"D)	\$280.00

Calf Pad Options

250DI34	Calf Pads, Pair, Standard	NC
250DI35	Extra Large Pair Calf Pads for Centermount Legrests, Fully adjustable (N/A w/ Std footplates)	\$351.00

POSITIONING SUPPORTS & ACCESSORIES

OPTION	DESCRIPTION	RETAIL
SEDEO® PRO™ Swing-Away Legrest (Pair) (250H179 is Client Cost)		\$
250H177	Legrests, Swing-Away, 70°, SEDEO® PRO™ (14" to 21" Leg Length)	NC
250H178	Legrests, Manual Elevating, Swing-Away, SEDEO® PRO™ (Includes Padded Calf Pads) (14".5 to 21.5" Leg Length)	\$596.00
250H179	Legrests, Power Elevating, Swing-Away, SEDEO® PRO™ (Includes Padded Calf Pads) (15.5" to 22.5" Leg Length)	\$3,384.00
250DI76	Omit Legrests	NC

Swing-Away Legrest Footplates

250F369	Angle Adjustable Flip-Up Footplates	\$280.00
---------	-------------------------------------	----------

Swing-Away Legrest Calf Supports

250DI42	Calf Support, Depth Adjustable, Padded (6.5" to 8" Wide, Depending On Chair Width, x 9.5" Tall)	\$504.00
---------	---	----------

Swing-Away Legrest Options

250DI44	Heel Loops	NC
250KG4	Knee Pads, Integral Foam (2.5" Wide x 4.5" Tall)	\$278.00

SEDEO® Lower Extremity Swing-Away Support

250VD01	Lower Extremity Support, Padded, Swing-Away, SEDEO®, Right	\$504.00
250VD02	Lower Extremity Support, Padded, Swing-Away, SEDEO®, Left	\$504.00

Pelvic Positioning Belts  P. 26

250A837	Positioning Belt, Auto Style Buckle, 50 mm 1600 mm / 2"	NC
250A839	Positioning Belt, Aircraft Buckle, 50 mm x 1300 mm / 2"	NC
250A840	Positioning Belt, Aircraft Buckle, Padded 50 mm x 1300 mm / 2"	\$101.00

Accessories

Ventilator Option		\$
250VT12	Vent Tray Fixed (Pulmonetic LTV Models)	\$600.00

O2 Tank Option

250A718	O2 Tank Holder Mounted to Backrest (D and E Styles)	\$385.00
---------	---	----------

Wheelchair Tray Table



2507A09	Tray, Swing-Away	\$375.00
---------	------------------	----------

Backpack (Client Cost)





250A1	Black Utility	\$110.00
-------	---------------	----------

Misc. Accessories (Client Cost)

2508A59	Transfer Bar (Pair)	\$486.00
2508A52	Ram Mount Phone	\$76.00
2508A53	Ram Mount Tablet	\$303.00
2508A54	Ram Mount Cup Holder	\$76.00
2508A58	Rear View Mirror	\$76.00

JOYSTICK / ELECTRONICS			
OPTION		DESCRIPTION	RETAIL
Seating Control <i>(Button Switches will not be mounted)</i>			\$
Switch Controls Only			
250E033		Dual Toggle for one Actuator	NC
250E034		Buddy Button for 1 actuator	NC
250E041		Crtl+5 Switch Box for 2 Actuators or More	NC
Toggle Mount			
250TN1		Toggle Mount, Right	NC
250TN2		Toggle Mount, Left	NC
Thru-Drive Control			
250E037		Thru-drive Control for 1 Actuator	\$1,422.00
250E038		Thru-drive Control for 2+ Actuators	\$2,860.00
Attendant Controls (Prior Approval Required)  P. 27			\$
2500A05		Dual Control Module for Attendant	\$1,207.00
2500A06		R-net Color LCD (CJSM1) Control Attendant Only	\$1,207.00
Attendant Mounting Location  P. 27			\$
250DN5		Right Back Cane	NC
2500DN6		Left Back Cane	NC
R-net Joystick <i>(Remote)</i>  P. 27			\$
250J121		Standard LED Joystick <i>(w/o Screen Display)</i>	NC
250J116		Color Joystick <i>(2.3" Color LCD Screen Display, CJSM1)</i>	NC
250J118		High Resolution Color Joystick,(CJSM2+BT) <i>3.5" Color LCD Display, Paddle Switches, Programmable Shortcut Keys, ICONs, Stereo Jack, IR and dual (IOS/Android) Bluetooth control (Client Cost)</i>	\$1,245.00
250J119		Omit Remote Control <i>(Required with arm mounted specialty controls)</i>	NC
Joystick Mounting			\$
250JM34		Fixed on Armrest	NC
250JM35		Parallel Swing-Away	\$440.00
250JM36		Link-It Mid Line Mount on Armrest <i>(Swing-Away)</i>	\$440.00
Joystick Mount (Location)			\$
250HM16		Right Hand Armrest	NC
250HM17		Left Hand Armrest	NC
Display Language Selection R-net			\$
250L1		English	NC
250L3		French	NC
250L7		Spanish	NC

JOYSTICK / ELECTRONICS

OPTION	DESCRIPTION	RETAIL
Joystick Handle (Optional) <i>N/A with HD Joystick</i>  P. 27		\$
250JH13	Ball Handle	\$108.00
250JH14	Foam Ball Handle	\$108.00
250JH24	Bodypoint - Rubber Dome Joystick Handle	\$213.00
250JH25	Bodypoint - U-Shaped Joystick Handle (4 inch)	\$213.00
250JH26	Bodypoint - Grooved Mushroom Joystick	\$213.00
Electronic Programmers  P. 27		\$
250PR10	R-net PC Programmer w/ Dongle	\$696.00
R-net Power Modules  P. 27		\$
250ER11	Power Module, R-net, 120A, Non-Expandable <i>(Only available with High Performance)</i>	NC
250ER10	Power Module, R-net, 120A, Expandable <i>((Includes Expandable Controller & Harness) (Only Available with High Performance))</i>	NC
250EX09	Expandable 120A Controller - R-net	
250EX10	Harness for 120A Expandable Controller	
250ER17	Power Module, R-net, 90A, Expandable <i>(Includes Expandable Controller & Harness)</i>	NC
250EX15	Expandable 90A Controller - R-net	
250EX16	Harness for 90A Expandable Controller	
Ctrl+5® Switchbox Options		\$
250QG11	Ctrl+5 Switch Box With Free Assignable Functions	\$1,062.00
250QG12	Ctrl+5 Switch Box With Free Assignable Functions <i>(Multi-power only)</i>	NC
Ctrl+5 Mounting location		
250EY19	Right Armrest	NC
250EY20	Left Armrest	NC
250EY21	Back Cane, Right	NC
250EY24	Back Cane, Left	NC
Ctrl+5® Switch Type  P. 27		\$
250EY22	Push Buttons	NC
250EY23	Toggle Switches	\$351.00
R-net Programming Selection		\$
Assignable Buttons		
<i>Assignable Button feature allows for modification of joystick buttons and/or Ctrl+5 Switches allowing access to various wheelchair and seating functions. When enabled, chair will be pre-programmed with seating functions assigned to buttons on the joystick. Assignments can be changed via PC Dongle.</i>		
250PM12	Include Assignable Buttons	NC
250PM13	Omit Assignable Buttons	NC

JOYSTICK / ELECTRONICS

OPTION	DESCRIPTION	RETAIL
R-net Programming Selection (cont'd)		\$
Power Centermount Footplate Extension Option (Client Cost)		
250IE03	Include 7.5" Powered Footplate Extension for Transfer Assist <i>(Electronics programmed to allow footplates to be extended with or without legrest being raised.) Only Available with Powered Articulation</i>	\$583.00
250IE04	Omit Footplate Extension for Transfers.	NC
R-net Omni2 Options  <i>P. 27 For Expandable Controls, choose all that apply.</i>		\$
2500N14	R-net Omni2 Only Input Control Module and 3.5" LCD Display w/ Built-In Infrared and Bluetooth® Choose Mount Below	\$2,349.00
2500N15	R-net Omni2 Bundled Input Control Module and 3.5" LCD Display w/ Built-In Infrared and Bluetooth® Bundled Omni2 Available w/ Switch-It Input Devices	NC
Omni2 Mount <i>If used w/ Standard Joystick, it must be mounted opposite side.</i>		\$
250DS14	Link-It with Parallel Swing-Away Omni2 Mount w/Rear Mounted Interface, Right	\$688.00
250DS15	Link-It with Parallel Swing-Away Omni2 Mount w/Rear Mounted Interface, Left	\$688.00

SPECIALTY INPUT DEVICES (AADL W100 Grant)

OPTION	DESCRIPTION	RETAIL
Hand Control Packages  P. 28 <i>Requires Standard Joystick Omit / Only one hand control device can be ordered.</i> \$		
Proportional Input Devices		
250EU14	Switch-It MicroGuide	\$4,574.00
250EU15	Switch-It MicroPilot	\$4,574.00
250EU17	Switch-It VersaGuide	\$2,519.00
250EU18	Switch-It VersaGuide EZ	\$2,978.00
Mounting Position (Required)		
250EM04	Link-It to the Backrest <i>(Not Available w/ Omit Back Cushion Type)</i>	\$1,318.00
250EM05	Link-It to the Fixed Joystick Mount	\$410.00
250EM06	Link-It to the Parallel Swing-Away Joystick Mount	\$410.00
250EM07	Link-It to the Midline Swing-Away	\$1,458.00
250EM08	Omit Mount	NC
Mounting Platforms (Optional) <i>Not available w/ Link-It to Backrest</i>		
250MG16	SunDisk Hand Tray <i>(Only available w/ MicroSeries Joysticks)</i>	\$410.00
250MG15	Bullet Hand Tray	\$410.00
Mounting Location (Required)		
250IM09	Right	NC
250IM10	Left	NC
Switch Options		
–	See Switch Selections <i>(Maximum 2)</i>	–

Head Control Packages  P. 28 *(Select headrest mount on next page)* **(AADL W100 Grant)** \$*Only one head control device can be ordered.***Proportional Input Devices**

250EU25	Switch-It DualPro® Proportional Head Array - Facial Pads	\$6,953.00
250EU26	Switch-It DualPro® Proportional Head Array - Spot Pads	\$6,953.00
Switched Input Devices		
250EU28	Switch-It 3-Switch Head Array - Short Curved Wings	\$6,063.00
250EU30	Switch-It 3-Switch Head Array - Long Curved Wings	\$6,063.00

SPECIALTY INPUT DEVICES (AADL W100 Grant)

OPTION	DESCRIPTION	RETAIL
Head Control Packages (cont'd) \$		
Switch Options		
–	See Switch Selections (<i>Maximum 2</i>)	–
Sip 'N Puff (AADL W100 Grant) \$		
250ID73	Switch-It Sip 'N Puff Combo Head Array with Link-It Hardware (<i>Requires headrest mount</i>)	\$6,933.00
250ID74	Switch-It OptiStop with Sip 'N Puff	\$2,700.00
Headrest Mounts (<i>Applies to Head/Sip 'N Puff control packages</i>) (AADL W100 Grant) \$		
250IJ13	Whitmyer® Linx Headrest Mount with Quick Release	\$243.00
250IJ14	Whitmyer® Linx-2 Headrest Mount with Quick Release	\$294.00
250IJ15	Whitmyer® AXYS Headrest Mount with Quick Release	\$243.00
Chin Control Packages (AADL W100 Grant) \$  P. 28		
Proportional Input Devices		
250EU34	Switch-It MicroGuide (<i>Switches mounted to the headrest only.</i>)	\$4,574.00
250EU35	Switch-It MicroPilot (<i>Switches mounted to the headrest only.</i>)	\$4,574.00
250EU36	Switch-It VersaGuide	\$2,519.00
250EU37	Switch-It VersaGuide EZ	\$2,978.00
Mounting Position		
250EM09	Link-It To Chin Harness, Small (150mm / 6")	\$1,734.00
250EM10	Link-It To Chin Harness, Large (220mm / 8")	\$1,734.00
250EM11	Link-It To Headrest, Swing-Away	\$1,734.00
250EM53	Link-It To Manual Chin Boom - Right Side	\$5,267.00
250EM54	Link-It To Manual Chin Boom - Left Side	\$5,267.00
250EM16	Omit Mount	NC
Input Device Mounting Location		
250IM13	Right	NC
250IM14	Left	NC
Switch Options		
–	See Switch Selections (<i>Minimum 1 for the Power Chin Boom, Maximum 3</i>)	–
Safety Devices (AADL W100 Grant) \$		
250SA06	Switch-It Remote Stop Switch - XLR Connector	\$1,298.00
Switched Driving Packages (AADL W100 Grant) \$		
250SW44	Switch-It Cool Cube with DB9 connector for proximity/proportional switch driving. (<i>Pro Spot proportional switches are required if proportional driving is desired.</i>) (<i>For non-proportional driving, single switches can be used.</i>)	\$3,891.00

SPECIALTY INPUT DEVICES

OPTION	DESCRIPTION	RETAIL
--------	-------------	--------

Switches  P. 29

Single switches can be programmed to activate any function of the wheelchair including: On/Off, Mode, Profile, Speeds, Seating, Memory Positions, Horn, Lights & Indicators, IR functions, Bluetooth mouse clicks, Environmental Controls when plugged into assignable port.

Switches can connect via: Joysticks (Standard, Micro series, Versa series, All-round series) Omni2, SJX6 Hub, head controls

Switch ordering instructions:

1. Select switch type and quantity in Section "A" using columns below. (Max 6 switches. See limitations below.)
2. Select switch mounting position from Section "B" using corresponding switch column.
3. Select switch mounting location from Section "C" using corresponding switch column.

Section A – Switch Selections**Switch / Quantity**

Single Function Switches - Mechanical Switches	Switch 1	Switch 2	Switch 3	Switch 4	Switch 5	Switch 6	\$
Buddy Button - Black							\$108.00
Buddy Button - Blue							\$108.00
Buddy Button - Green							\$108.00
Buddy Button - Red							\$108.00
Buddy Button - Yellow							\$108.00
Egg Switch - Black							\$108.00
Egg Switch - Blue							\$108.00
Egg Switch - Green							\$108.00
Egg Switch - Red							\$108.00
Egg Switch - Yellow							\$108.00
MicroLite <i>(Includes color labels)</i>							\$113.00
Mini Button 1 - Blue <i>(Velcro)</i>							\$303.00
Mini Button 1 - Green <i>(Velcro)</i>							\$303.00
Mini Button 1 - Red <i>(Velcro)</i>							\$303.00
1" Single Switch - Black							\$382.00
1" Single Switch - Blue							\$382.00
1" Single Switch - Green							\$382.00
1" Single Switch - Orange							\$382.00
1" Single Switch - Red							\$382.00
1" Single Switch - Yellow							\$382.00
Electronic Switches							
Flex Switch (Headrest mount only)							\$534.00
ProSpot - Proportional Switches							
ProSpot Proportional Switch - Red							\$534.00
ProSpot Proportional Switch - Green							\$534.00
ProSpot Proportional Switch - Blue							\$534.00
ProSpot Proportional Switch - Yellow							\$534.00
ProSpot Proportional Switch - Orange							\$534.00
Joystick Integrated Switches (Pair)							
Proximity Switches on Flex Mount, Pair (used with VersaGuide/VersayGuide EZ)							\$1,382.00

Section B – Switch Mounting Position

Link-It to the Backrest (Up to 1 per side)							\$1,388.00
Link-It to the Headrest - Gooseneck & Rigid (Up to 2 per side)							\$1,734.00
Link-It to the Fixed Joystick Mount (Up to 2 per side)							\$410.00
Link-It to the Parallel Swing-Away Joystick Mount (Up to 2 per side)							\$410.00
Link-It to the Seat Rail (Up to 2 per side) <i>(Not avail w/knee & thigh supports)</i>							\$548.00
Omit Mount (includes Velcro)							NC

Section C – Switch Mounting Location

Right side of chair							NC
Left side of chair							NC

JAY® SYNCRA™ SEATING MEASURING GUIDE

JAY® SYNCRA™ BACK



Backrest Width	16"	18"	20"	22"
Max User Trunk Width	13.5"	15.5"	17.5"	19.5"

JAY® Swing-Away Lateral Thoracic Adjustment Range

Syncra Back Width	Width Range	Height range from bottom of shell to seat pan
16"	10" to 24"	12" to 19.5"
18"	12" to 26"	12.5" to 21.5"
20"	14" to 28"	12.5" to 22"
22"	16" to 30"	13.5" to 23"

Syncra™ Fixed Lateral Support Accessory Range

Syncra Back Width	Width Range	Height range from bottom of shell to seat pan	Contour Depth Range
16"	16.4" to 16.8"	6" to 8"	3" to 5"
18"	18.4" to 18.8"	6" to 8"	3" to 5"
20"	20.4" to 20.8"	6" to 8"	3" to 5"
22"	22.4" to 22.8"	6" to 8"	3" to 5"

Syncra™ Back Shell Height Diagram

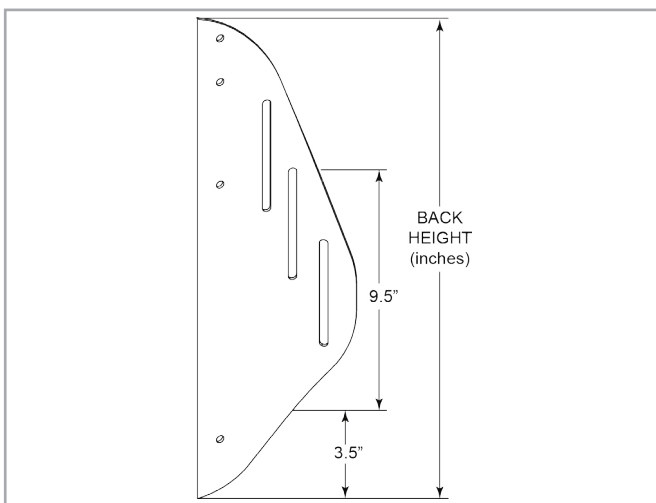

JAY® SYNCRA™ CUSHION



JAY® Lateral Thigh Support Adjustment Range

Syncra Cushion Width	Width Range
16"	8.5" to 16.0"
17"	9.5" to 17.0"
18"	10.5" to 18.0"
19"	11.5" to 19.0"
20"	12.5" to 20.0"
22"	14.5" to 22.0"



Q700 M with SEDEO® LITE™

\$

Base Price	
Total of additional equipment	
Packaging and transport	
Total Price	

Date

Signature

Month Day Year



Customer Service: (800) 263-3390
Fax: (800) 561-5834
E-mail: cscanada@sunmed.com
www.sunrisemedical.ca
Specifications are subject to change without notice.

© 2024 Sunrise Medical Canada Inc.
1000 Creditstone Road, Unit 2
Concord, Ontario
L4K 4P8
MK-129632-AADL, Rev. 8